

Amazing

PHYSICS

FORMULA

KBSM + KSSM

**DREAM BIG
AIM HIGH
NEVER GIVE UP**

alinainanarif

EQUATIONS OF MOTION

$$v = u + at$$

$$s = ut + \frac{1}{2}at^2$$

$$s = \frac{(u + v)}{2}t$$

$$v^2 = u^2 + 2as$$

SPEED / VELOCITY:

$$v = \frac{s}{t}$$

ACCELERATION:

$$a = \frac{v - u}{t}$$

MOMENTUM:

$$p = mv$$

ELASTIC COLLISION:

$$m_1u_1 + m_2u_2 = m_1v_1 + m_2v_2$$

INELASTIC COLLISION:

$$m_1u_1 + m_2u_2 = (m_1 + m_2)v$$

FORCE:

$$F = ma$$

IMPULSIVE FORCE:

$$F = \frac{m(v - u)}{t}$$

IMPULSE:

$$Ft = mv - mu$$

WEIGHT:

$$W = mg$$

WORK DONE / ENERGY: $W = Fs$

POWER: $P = \frac{W}{t} = \frac{E}{t}$

KINETIC ENERGY: $E_k = \frac{1}{2}mv^2$

GRAVITATIONAL POTENTIAL ENERGY: $E_p = mgh$

EFFICIENCY: $E = \frac{E_{out}}{E_{in}} \times 100\%$

HOOKE'S LAW:

$$F = kx$$

SPRING CONSTANT:

$$k = \frac{F}{x}$$

ELASTIC POTENTIAL ENERGY:

$$E_p = \frac{1}{2}Fx = \frac{1}{2}kx^2$$

PRESSURE: $P = \frac{F}{A}$

PRESSURE IN LIQUID: $P = \rho gh$

$$P_{\text{atm}} = 1.0 \times 10^5 \text{ Pa}$$

$$= 76 \text{ cm Hg}$$

$$= 10 \text{ m water}$$

$$= 1 \text{ Bar}$$

$$= 1 \text{ atm}$$

PASCAL'S PRINCIPLE:

$$P = \frac{F_1}{A_1} = \frac{F_2}{A_2}$$

$$P = A_1 h_1 = A_2 h_2$$

BUOYANT FORCE:

$$F_B = \rho V g$$

TEMPERATURE OF LIQUID:

$$T(\theta) = \frac{l_{\theta} - l_0}{l_{100} - l_0} \times 100 \text{ }^{\circ}\text{C}$$

TRANSFORMATION OF ENERGY:

$$\frac{1}{2}mv^2 = mc\theta$$

$$mgh = mc\theta$$

$$Pt = mc\theta$$

HEAT ENERGY: $Q = mc\theta$

LATENT HEAT ENERGY: $Q = mL$

Boyle's law

$$P_1V_1 = P_2V_2$$

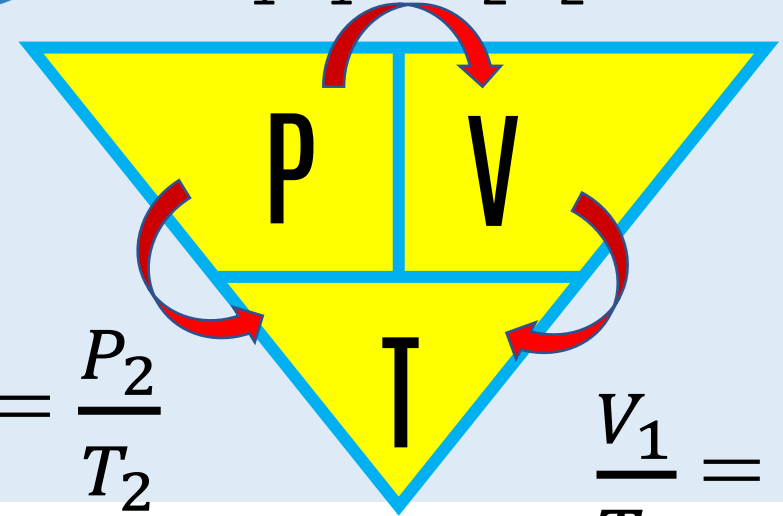

$$\frac{P_1}{T_1} = \frac{P_2}{T_2}$$

Pressure law

$$\frac{V_1}{T_1} = \frac{V_2}{T_2}$$

Charles' law



Important Notes:

$$T = (\theta \text{ }^{\circ}\text{C} + 273) \text{ K}$$

REFRACTIVE INDEX:

$$\eta = \frac{\sin i}{\sin r}$$

$$= \frac{\text{speed in air}}{\text{speed in medium}}$$

$$= \frac{H(\text{Real})}{h(\text{Apparent})}$$

$$\eta = \frac{1}{\sin C}$$

POWER OF LENS:

$$P = \frac{1}{f}$$

LINEAR MAGNIFICATION:

$$m = \left| \frac{v}{u} \right| = \frac{h_i}{h_o}$$

LENS EQUATION:

$$\frac{1}{f} = \frac{1}{u} + \frac{1}{v}$$

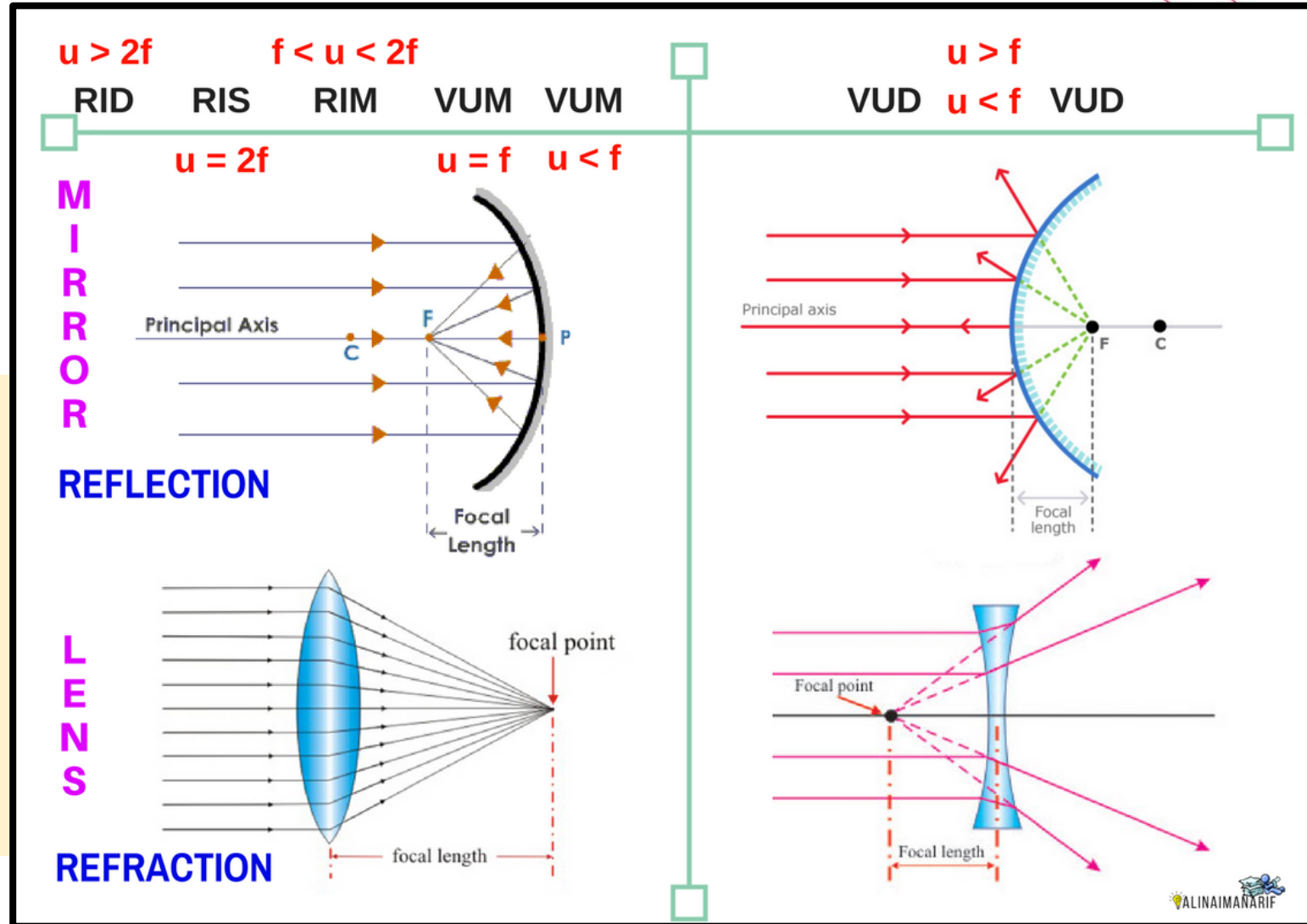



POWER OF LENS:

$$P = \frac{1}{f}$$

**LINEAR
MAGNIFICATION:**

$$m = \frac{f_o}{f_e}$$

CHARACTERISTICS	MICROSCOPE	TELESCOPE
DIAGRAM		
f_o (objective lens)	$P \uparrow$ so $f \downarrow$ To produce bigger image	$P \downarrow$ so $f \uparrow$ To produce a higher magnification
f_e (eyepiece lens)	$f \uparrow$	$f \downarrow$
D (normal adjustment)	$D > f_o + f_e$ To produce bigger image from the eyepiece // to increase the magnification	$D = f_o + f_e$ To produce sharp & bright image
u (object distance)	$f < u < 2f$ (RIM)	Infinity (∞) (RID)
First image	RIM	RID (at f)
Final image	VIM	VIM (∞)

Displacement of the particle (cm)

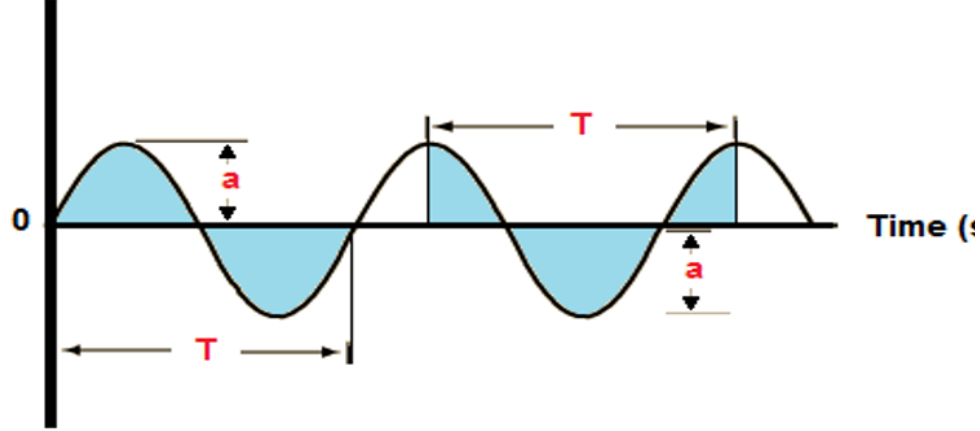

Displacement of the particle (cm)

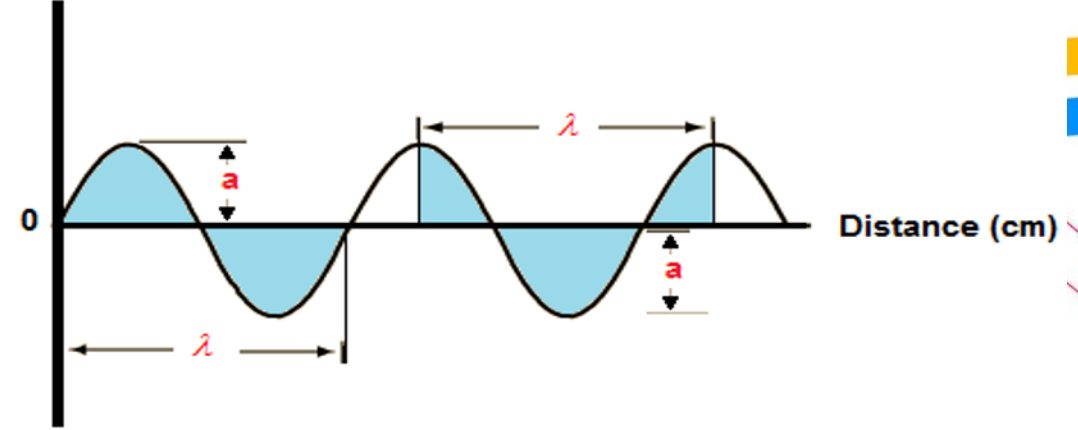

PERIOD:

$$T = \frac{1}{f}$$

FREQUENCY:

$$f = \frac{1}{T}$$

SPEED OF WAVES:

$$v = f \lambda$$

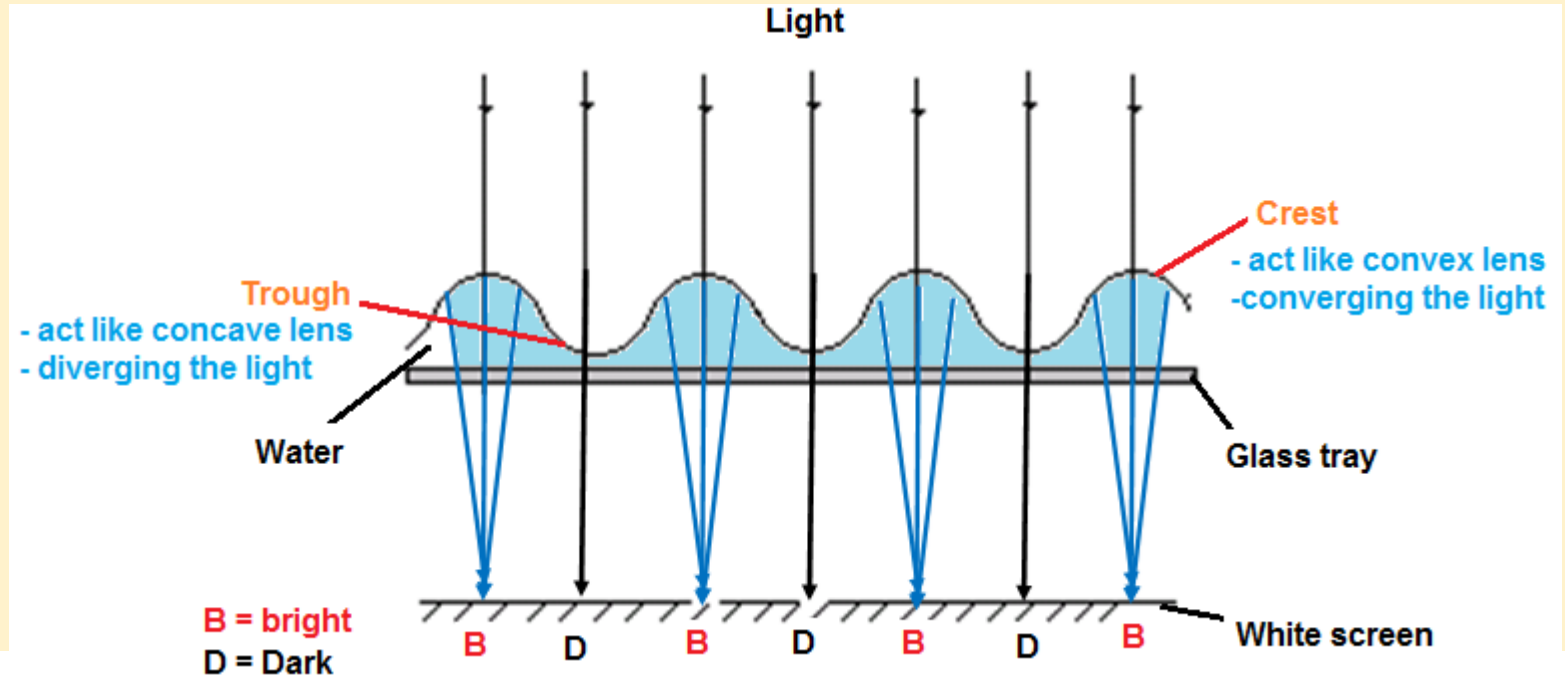

Characteristics of the **REFLECTION** of waves:

Physical Quantity	INCIDENCE WAVE	REFLECTED WAVE
Frequency	Unchanged (come from the same source; water wave)	
Speed	Unchanged	
Wavelength	Unchanged	
Direction of Propagation	Changed	

Characteristics of the **REFRACTION** of waves:

Physical Quantity	SHALLOW AREA	DEEP AREA
Frequency	Unchanged (come from the same source; water wave)	
Velocity	Decrease	Increase
Wavelength	Decrease	Increase
Direction of Propagation	Bends towards the normal line	Bends away the normal line

Characteristics of the **DIFFRACTION** of waves:

Physical Quantity	Condition (diffracted waves)
Frequency	Unchanged (come from the same source; water wave)
Speed	Unchanged
Wavelength	Unchanged
Amplitude (Energy)	Decrease

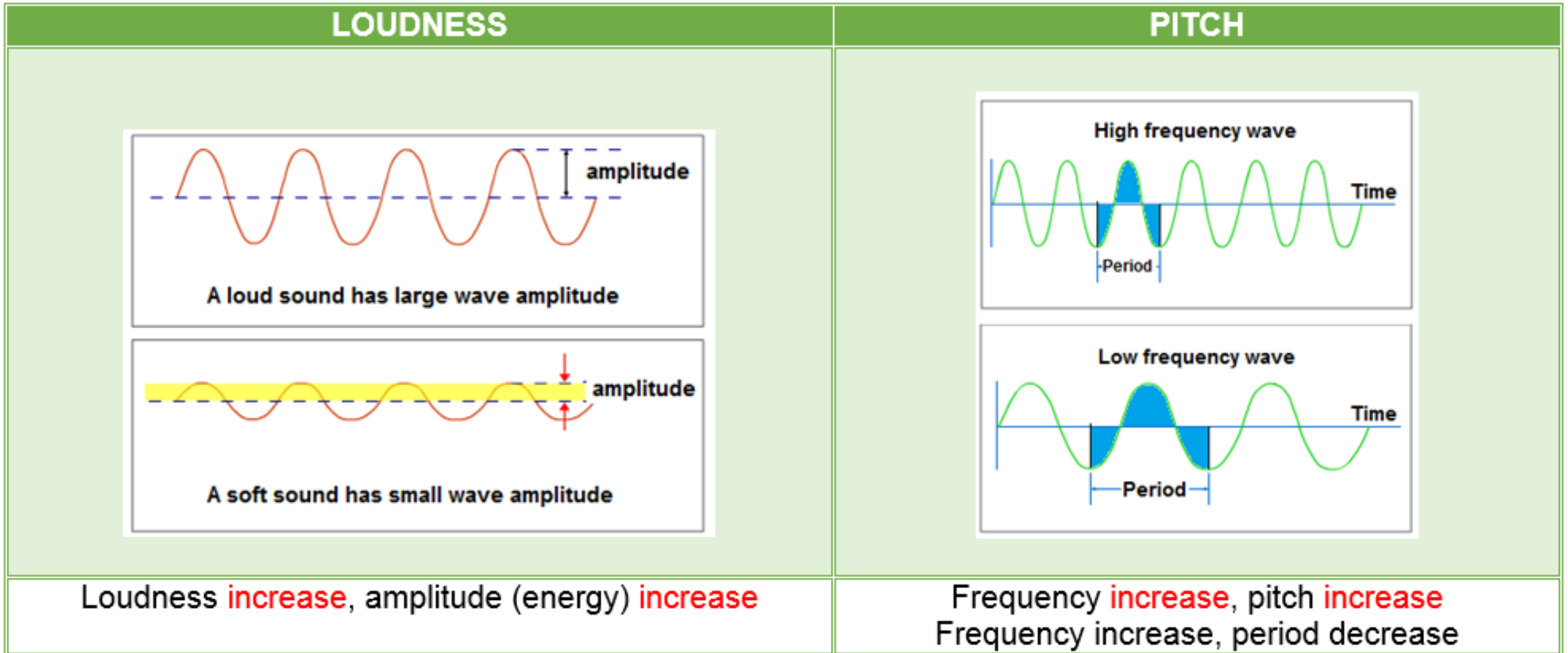

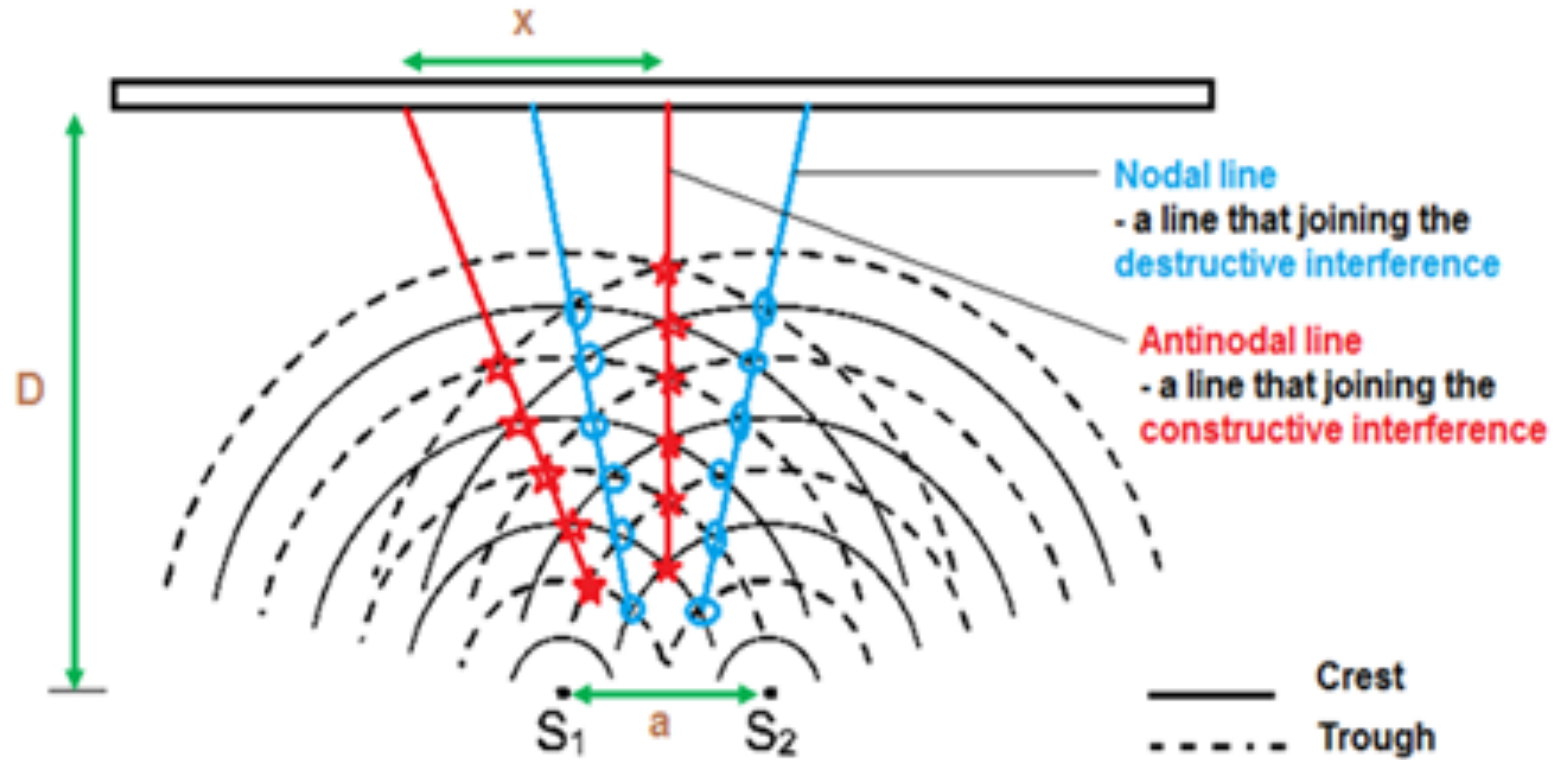

$$\lambda = \frac{ax}{D}$$

λ = wavelength of water waves

a = distance between two dippers

x = distance between two consecutive antinodal line or nodal line

D = distance between dippers and screen

The wavelength of **monochromatic** light can be found by the formula:

a = distance between two slits

x = distance between two consecutive bright fringe or dark fringe

D = distance between slits and screen

$$\lambda = \frac{ax}{D}$$

When **constructive** occurs there will be a **bright fringe**.
When **destructive** occurs there will be a **dark fringe**.

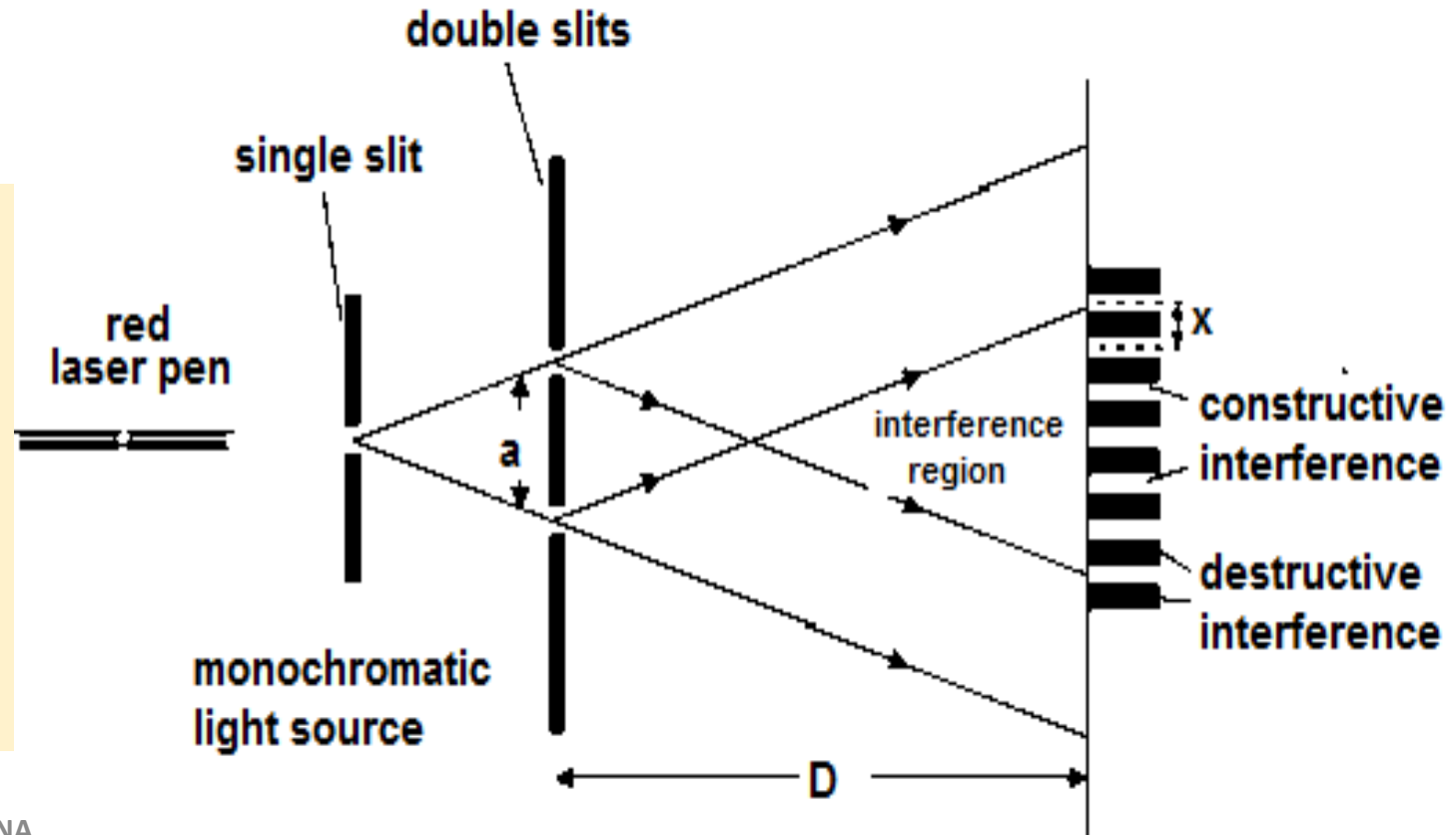

The wavelength of **sound wave** can be found by the formula:

a = distance between two loudspeakers

x = distance between two consecutive loud sound or soft sound

D = distance between loudspeakers and where the sound heard

$$\lambda = \frac{ax}{D}$$

When **constructive** occurs there will be a **loud sound**.
When **destructive** occurs there will be a **soft sound**.

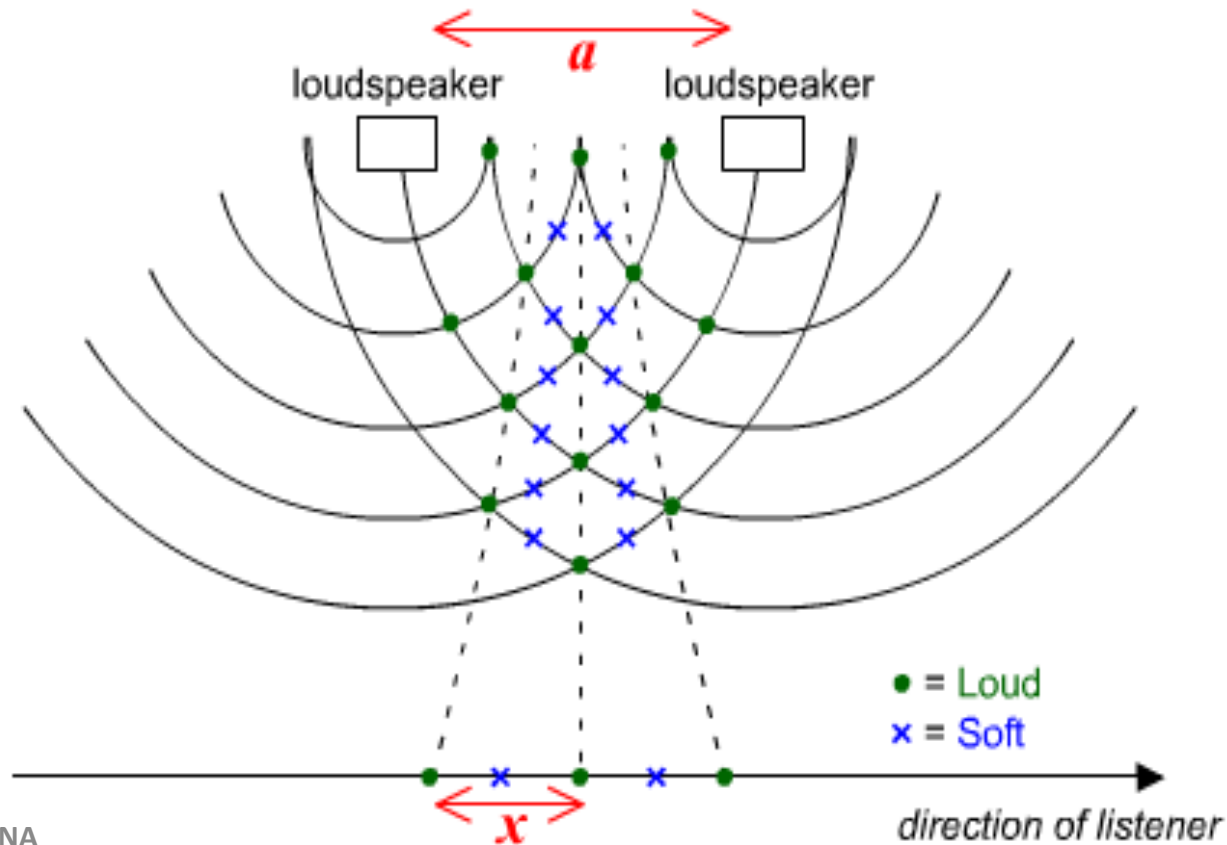

ELECTRIC CURRENT:

$$I = \frac{Q}{t} = \frac{ne}{t}$$

POTENTIAL DIFFERENCE:

$$V = \frac{W}{Q} = \frac{E}{It} = IR$$

RESISTANCE:

$$R = \frac{V}{I} = \frac{\rho l}{A}$$

OHM'S LAW:

$$V = IR$$

ELECTROMOTIVE FORCE:

$$E = I(R + r)$$

$$E = V + Ir$$

INTERNAL RESISTANCE:

$$m = -r$$

$$= -\left(\frac{E - V}{I}\right)$$

ELECTRICAL POWER:

$$P = \frac{W}{t} = \frac{E}{t} = IV = I^2R = \frac{V^2}{R}$$

ELECTRICAL ENERGY:

$$E = Pt$$

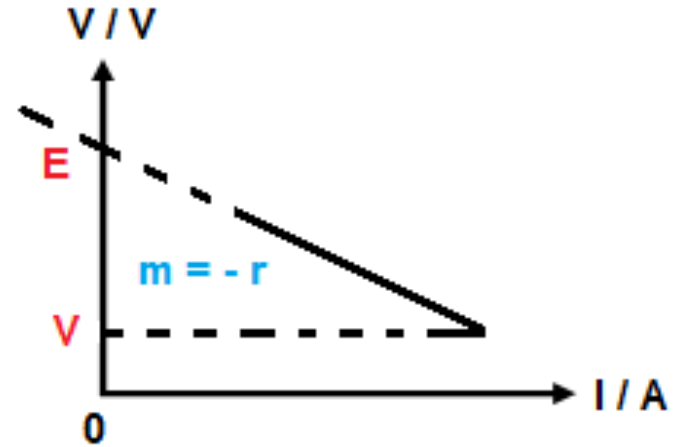

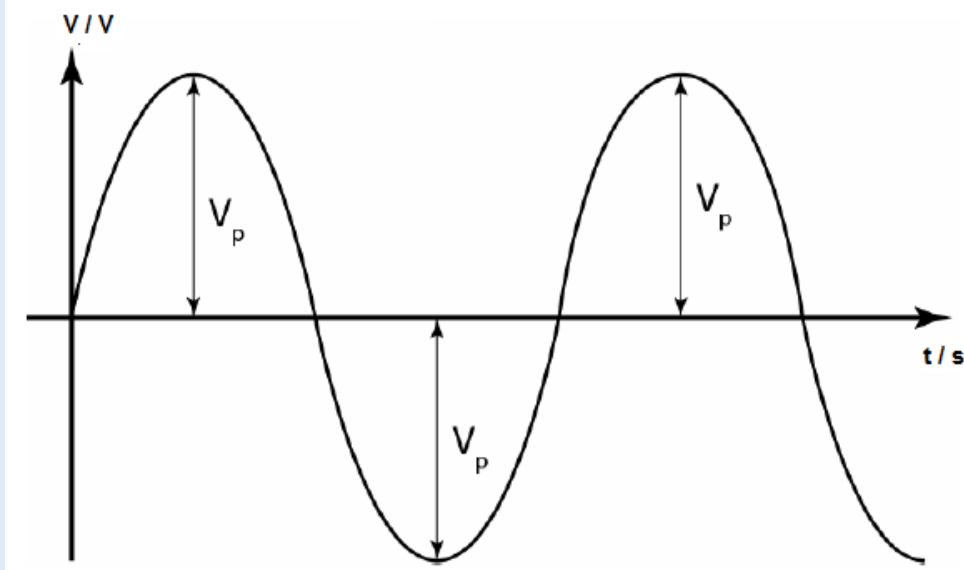
ROOT MEAN SQUARE VALUE:

$$V_{\text{rms}} = \frac{V_p}{\sqrt{2}}$$

V_{rms} = root mean square voltage (V)

V_p = peak voltage (V)

$$I_{\text{rms}} = \frac{I_p}{\sqrt{2}}$$

I_{rms} = root mean square current (A)

I_p = peak current (A)

TRANSFORMER:

$$\frac{V_s}{V_p} = \frac{N_s}{N_p}$$

IDEAL TRANSFORMER:

$$V_p I_p = V_s I_s$$

NON-IDEAL TRANSFORMER:

$$\text{Efficiency} = \frac{V_s I_s}{V_p I_p} \times 100\%$$

ENERGY CHANGE OF ELECTRON IN AN ELECTRON GUN:

Kinetic Energy → Electrical Potential Energy

$$\frac{1}{2}mv^2 = eV$$

$$v = \sqrt{\frac{2eV}{m}}$$

v = speed of electron (ms^{-1})

V = potential difference across the electron gun (V)

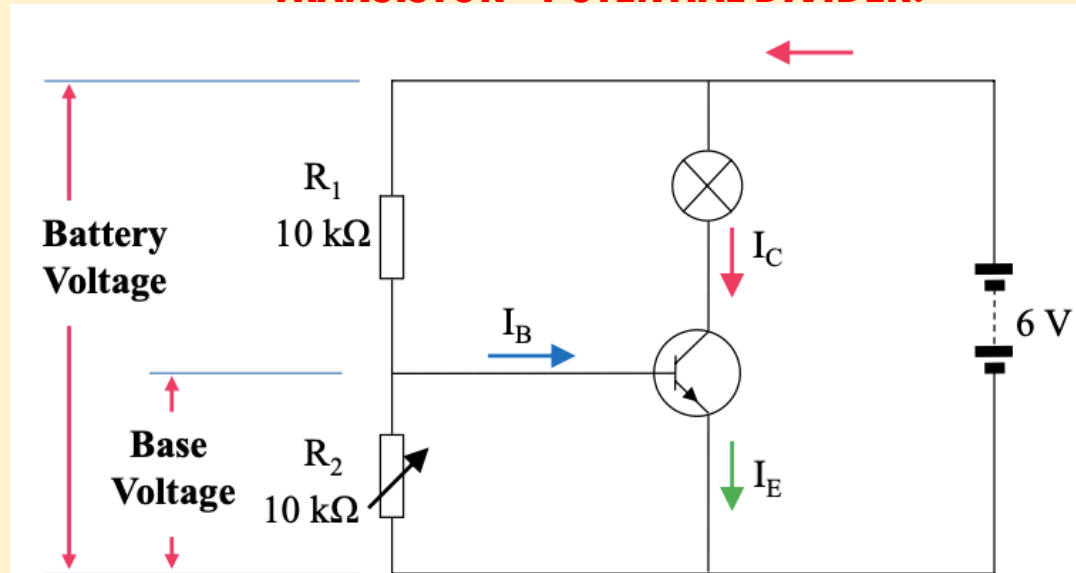
e = charge of 1 electron ($1.66 \times 10^{-19} \text{ C}$)m = mass of 1 electron ($3.11 \times 10^{-31} \text{ kg}$)**TRANSISTOR - POTENTIAL DIVIDER:**





$$V_1 + V_2 = V$$

$$V_1 = \left(\frac{R_1}{R_1 + R_2} \right) V$$

$$V_2 = \left(\frac{R_2}{R_1 + R_2} \right) V$$

Logic Gate

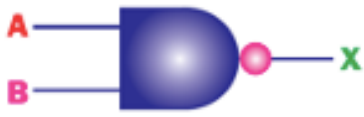
has **one** or **more** **input** signals but only **one** **output** signal

GATES	SYMBOL	BOOLEAN EXPRESSION	TRUTH TABLE																		
AND gate		$X = A \cdot B$	<table border="1"> <thead> <tr> <th colspan="2">INPUT</th> <th>OUTPUT</th> </tr> <tr> <th>A</th> <th>B</th> <th>X</th> </tr> </thead> <tbody> <tr> <td>0</td> <td>0</td> <td>0</td> </tr> <tr> <td>0</td> <td>1</td> <td>0</td> </tr> <tr> <td>1</td> <td>0</td> <td>0</td> </tr> <tr> <td>1</td> <td>1</td> <td>1</td> </tr> </tbody> </table>	INPUT		OUTPUT	A	B	X	0	0	0	0	1	0	1	0	0	1	1	1
INPUT		OUTPUT																			
A	B	X																			
0	0	0																			
0	1	0																			
1	0	0																			
1	1	1																			
OR gate		$X = A + B$	<table border="1"> <thead> <tr> <th colspan="2">INPUT</th> <th>OUTPUT</th> </tr> <tr> <th>A</th> <th>B</th> <th>X</th> </tr> </thead> <tbody> <tr> <td>0</td> <td>0</td> <td>0</td> </tr> <tr> <td>0</td> <td>1</td> <td>1</td> </tr> <tr> <td>1</td> <td>0</td> <td>1</td> </tr> <tr> <td>1</td> <td>1</td> <td>1</td> </tr> </tbody> </table>	INPUT		OUTPUT	A	B	X	0	0	0	0	1	1	1	0	1	1	1	1
INPUT		OUTPUT																			
A	B	X																			
0	0	0																			
0	1	1																			
1	0	1																			
1	1	1																			
NOT gate		$X = \bar{A}$	<table border="1"> <thead> <tr> <th>INPUT</th> <th>OUTPUT</th> </tr> <tr> <th>A</th> <th>X</th> </tr> </thead> <tbody> <tr> <td>0</td> <td>1</td> </tr> <tr> <td>1</td> <td>0</td> </tr> </tbody> </table>	INPUT	OUTPUT	A	X	0	1	1	0										
INPUT	OUTPUT																				
A	X																				
0	1																				
1	0																				
NAND gate		$X = \overline{A \cdot B}$	<table border="1"> <thead> <tr> <th colspan="2">INPUT</th> <th>OUTPUT</th> </tr> <tr> <th>A</th> <th>B</th> <th>X</th> </tr> </thead> <tbody> <tr> <td>0</td> <td>0</td> <td>1</td> </tr> <tr> <td>0</td> <td>1</td> <td>1</td> </tr> <tr> <td>1</td> <td>0</td> <td>1</td> </tr> <tr> <td>1</td> <td>1</td> <td>0</td> </tr> </tbody> </table>	INPUT		OUTPUT	A	B	X	0	0	1	0	1	1	1	0	1	1	1	0
INPUT		OUTPUT																			
A	B	X																			
0	0	1																			
0	1	1																			
1	0	1																			
1	1	0																			
NOR gate		$X = \overline{A + B}$	<table border="1"> <thead> <tr> <th colspan="2">INPUT</th> <th>OUTPUT</th> </tr> <tr> <th>A</th> <th>B</th> <th>X</th> </tr> </thead> <tbody> <tr> <td>0</td> <td>0</td> <td>1</td> </tr> <tr> <td>0</td> <td>1</td> <td>0</td> </tr> <tr> <td>1</td> <td>0</td> <td>0</td> </tr> <tr> <td>1</td> <td>1</td> <td>0</td> </tr> </tbody> </table>	INPUT		OUTPUT	A	B	X	0	0	1	0	1	0	1	0	0	1	1	0
INPUT		OUTPUT																			
A	B	X																			
0	0	1																			
0	1	0																			
1	0	0																			
1	1	0																			

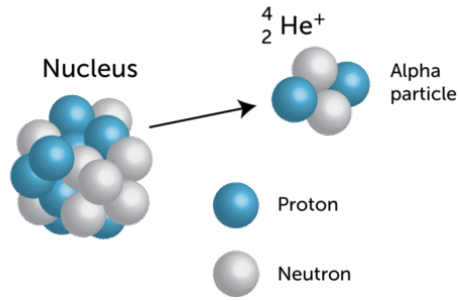

α -decay

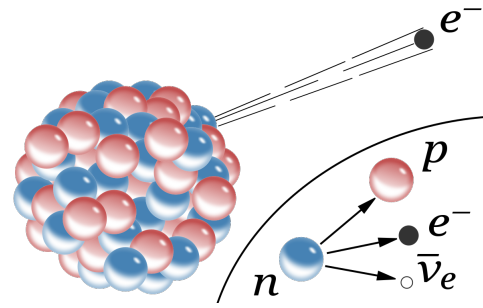
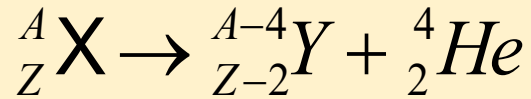

β -decay

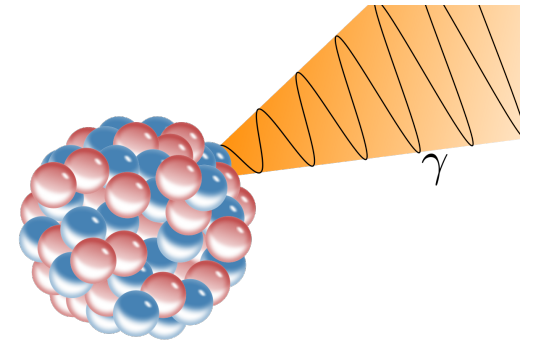
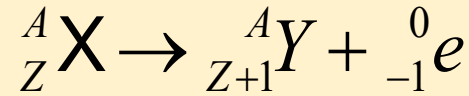

γ -decay

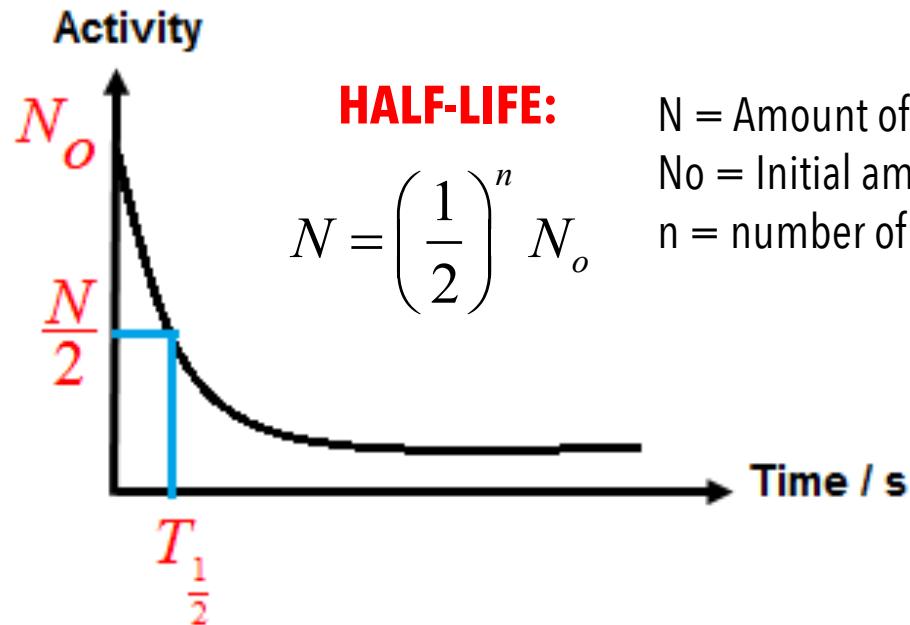
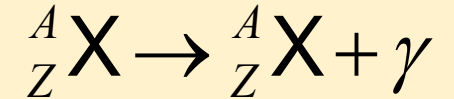

NUCLEAR ENERGY:

$$E = mc^2$$

m = mass change (kg)

c = speed of light ($3 \times 10^8 \text{ ms}^{-1}$)

E = energy changed (J)

GRAVITATIONAL FORCE

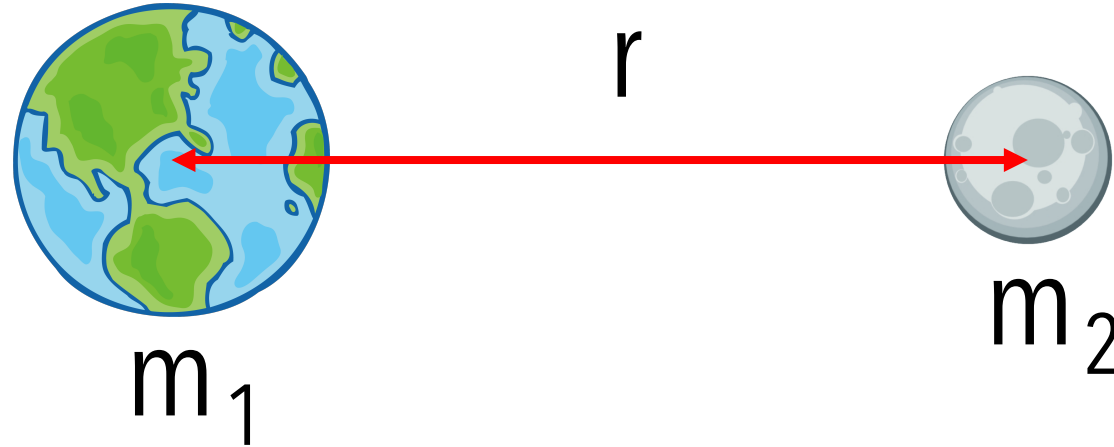

$$F = \frac{G m_1 m_2}{r^2}$$

F = Gravitational force between two objects

G = Universal gravitational constant
($6.67 \times 10^{-11} \text{ N m}^2 \text{ kg}^{-2}$)

m_1 = mass of first object

m_2 = mass of second object

r = distance between the center of two objects

RELATIONSHIP BETWEEN g and G

Newton's Second Law of Motion

$$F = mg$$

.....1

Newton's Universal Law of Gravitation

$$F = \frac{GmM}{r^2}$$

.....2

Equation 1 = Equation 2

$$mg = \frac{GmM}{r^2}$$

$$g = \frac{GM}{r^2}$$

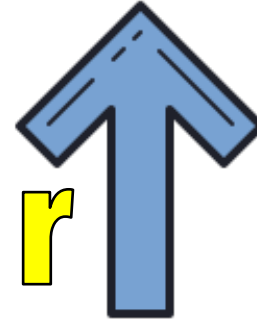
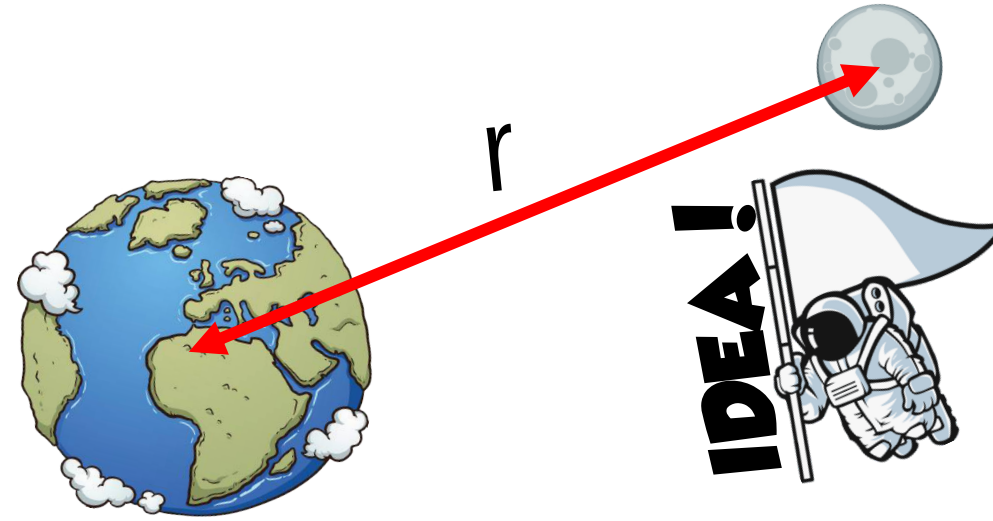

Gravitational acceleration

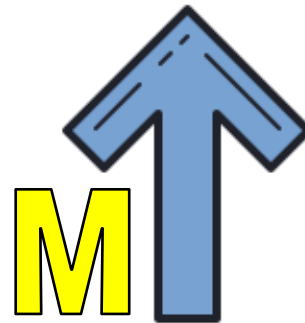
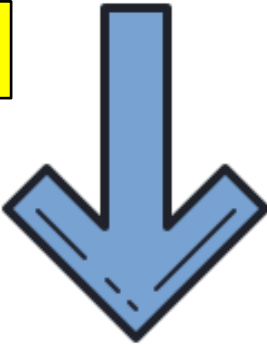

Gravitational acceleration

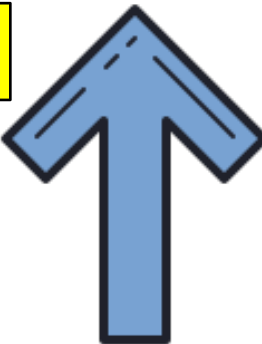

RELATIONSHIP BETWEEN g and G

- g = Gravitational acceleration
 G = Universal gravitational constant ($6.67 \times 10^{-11} \text{ N m}^2 \text{ kg}^{-2}$)
 M = mass of object
 r = distance between the centers

$$g = \frac{GM}{(R + h)^2}$$

$$g = \frac{GM}{r^2}$$

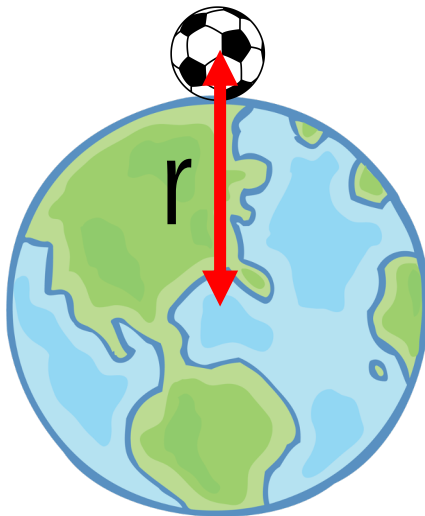

On the surface

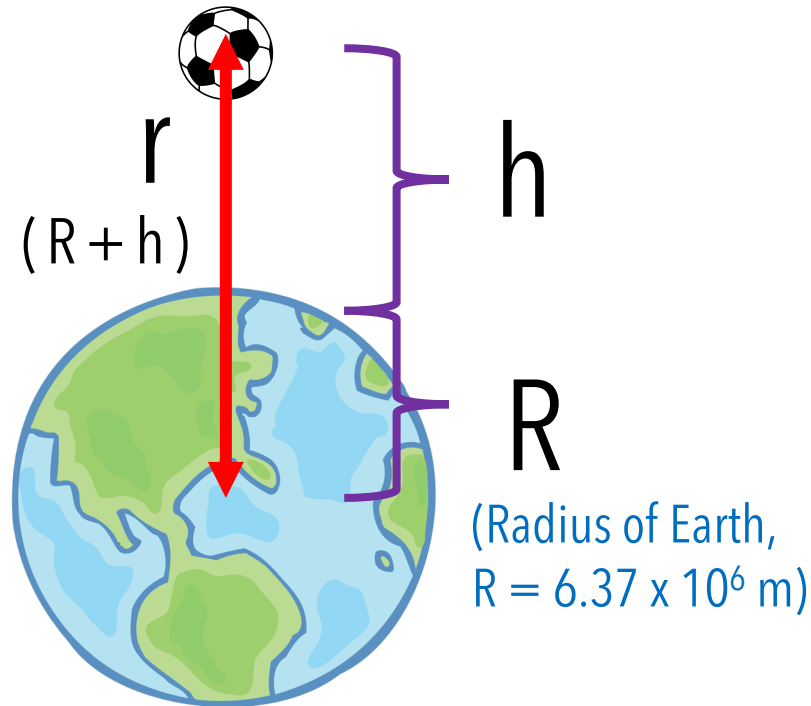

At a height

$$g = \frac{GM}{(R - h)^2}$$

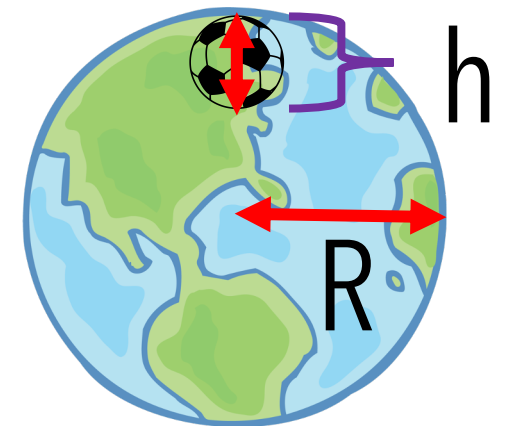

Below the surface

CENTRIPETAL FORCE

For an object in a circular motion

$$F = \frac{mv^2}{r}$$

- F** = Centripetal force
- m** = mass of orbiting body
- v** = linear speed
- r** = radius of orbit

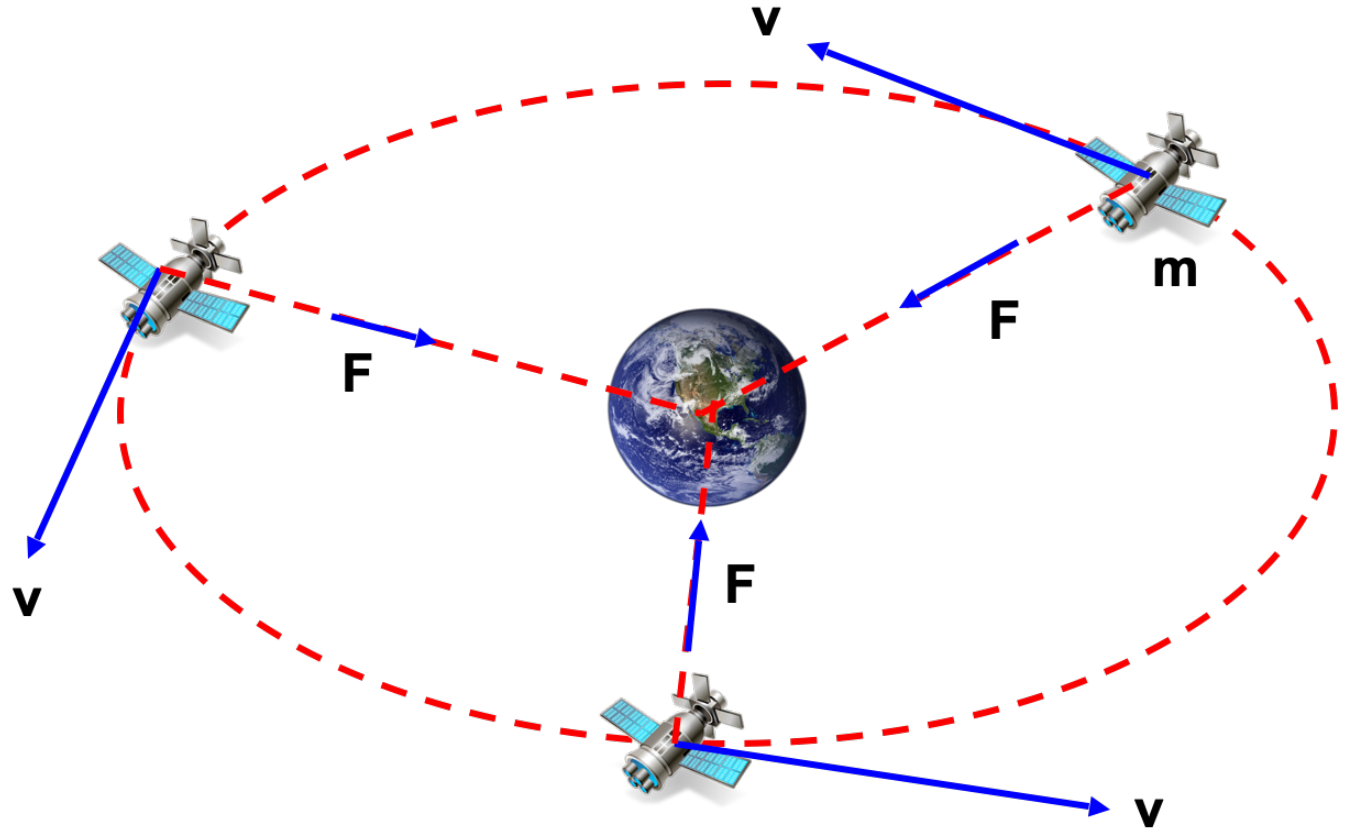

CENTRIPETAL FORCE

For an object in a circular motion

$$F = \frac{mv^2}{r}$$

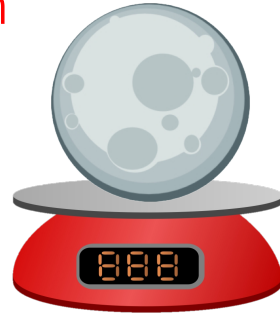

Mass



F

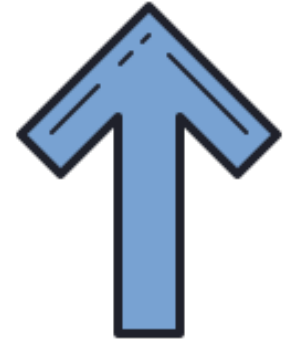

Speed



F

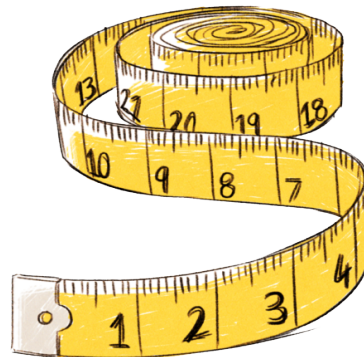
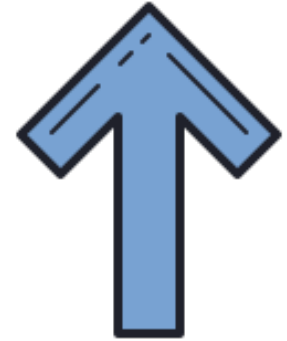

r



F



CENTRIPETAL ACCELERATION

Acceleration of an object in a circular motion

$$a = \frac{v^2}{r}$$

- a** = Centripetal acceleration
- v** = linear speed
- r** = radius of orbit

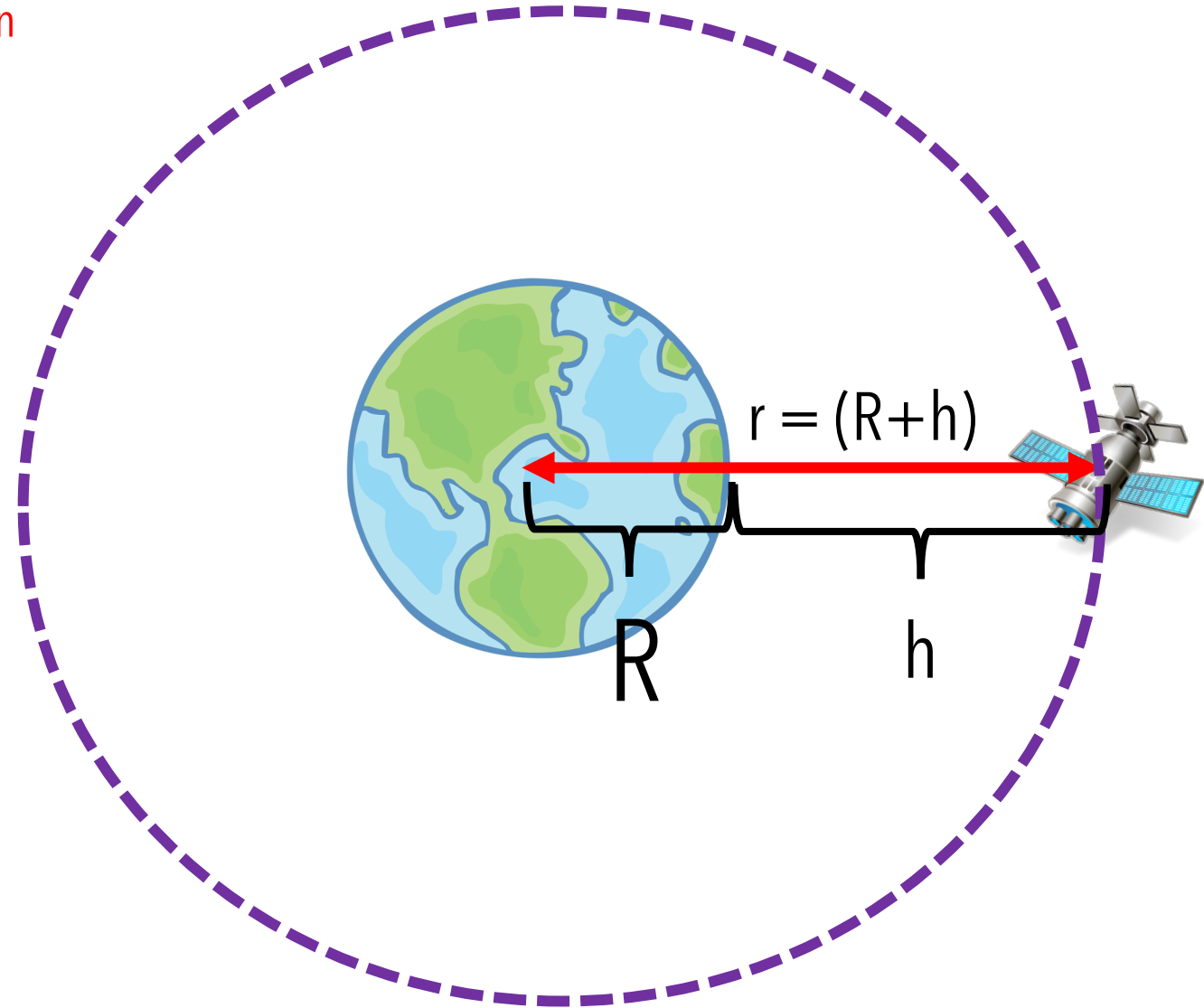

MASS OF A BODY

Mass of a body at the centre of an orbit

$$M = \frac{4\pi^2 r^3}{GT^2}$$

- M** = Mass (object at center)
- G** = gravitational constant
($6.67 \times 10^{-11} \text{ N m}^2 \text{ kg}^{-2}$)
- r** = radius of orbit
- T** = Period of revolution
(time taken to circle the orbit)

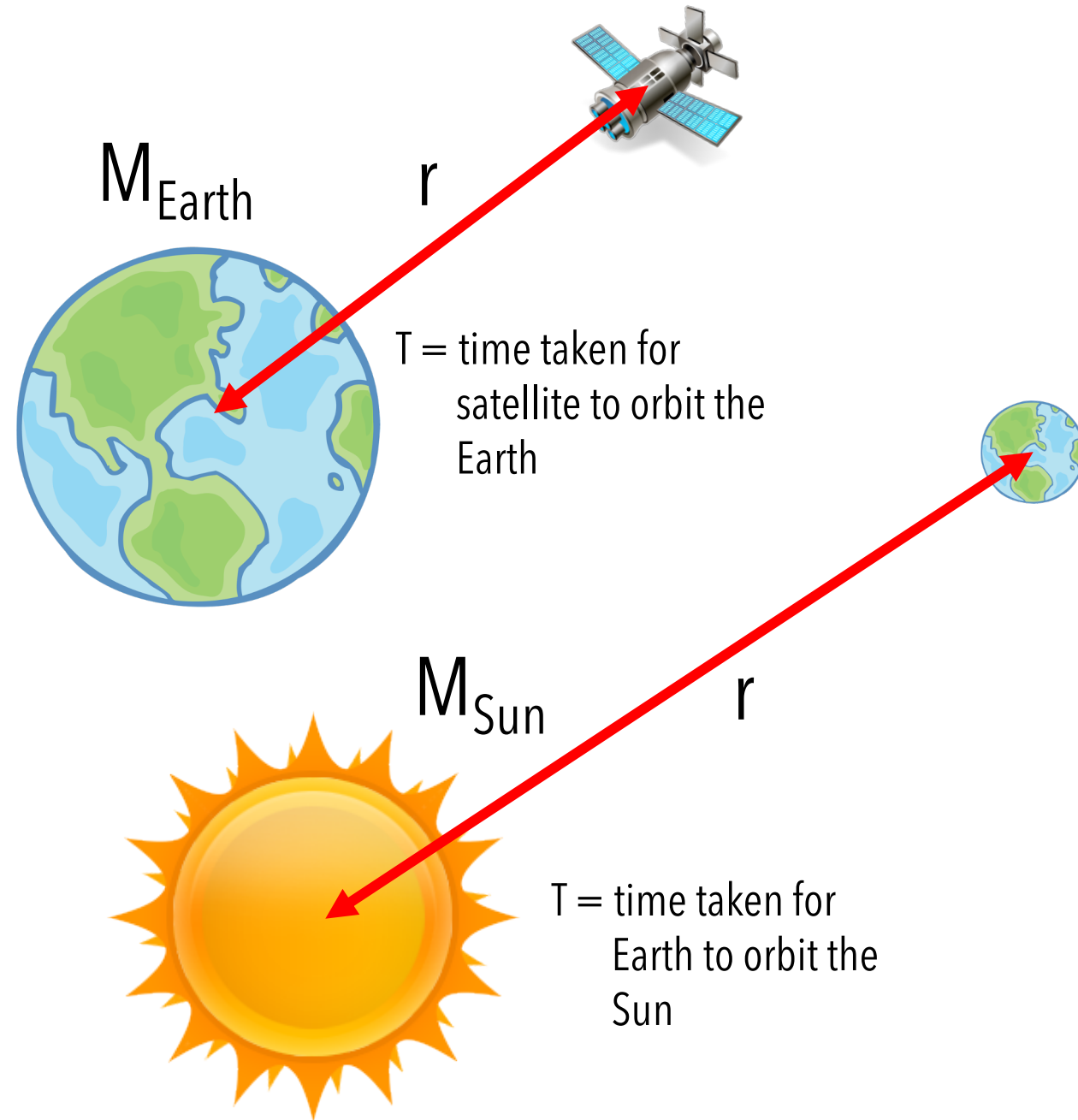

KEPLER'S

1

All planets move in **elliptical orbits** with the **SUN** at **one focus**

Perihelion point

a place where the planet is the **closest** to the Sun

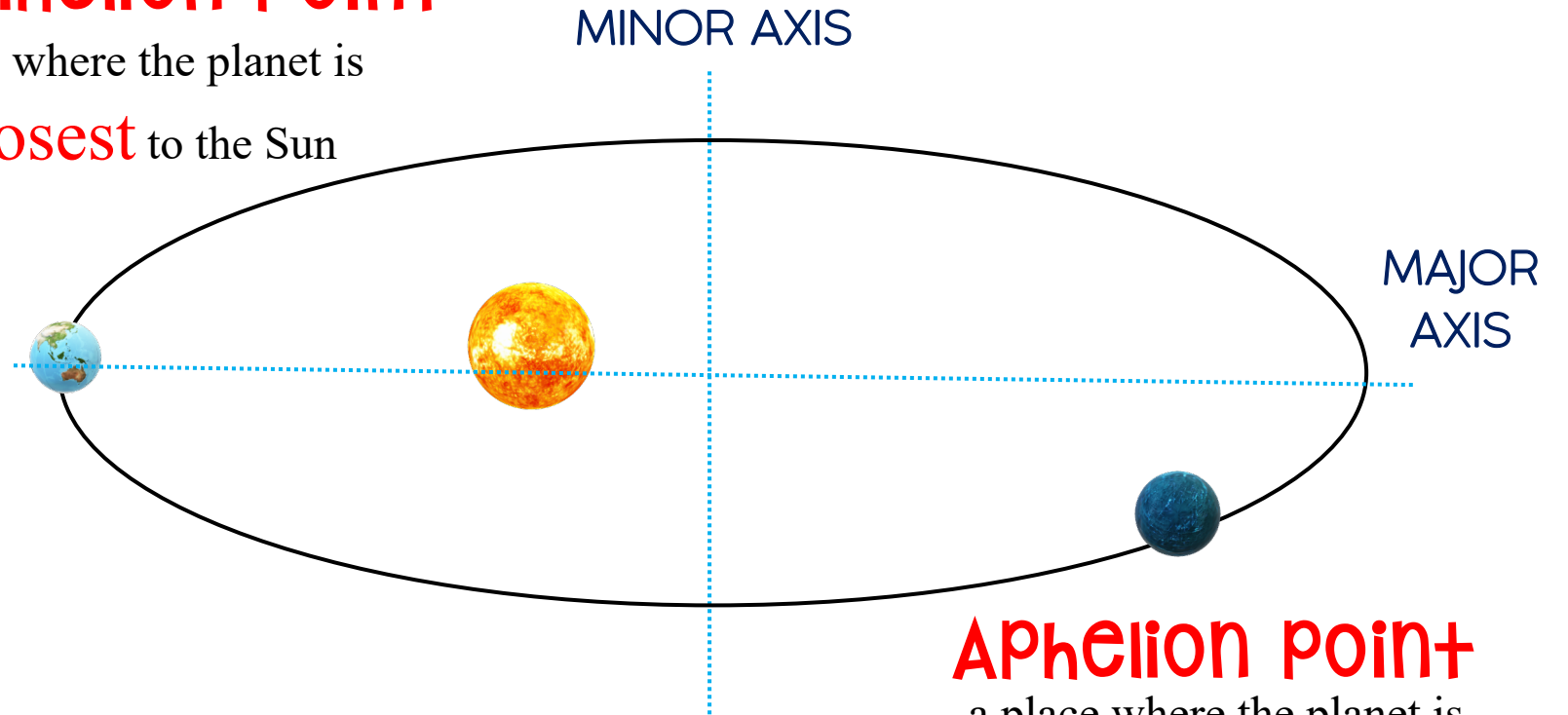
**Aphelion point**





a place where the planet is the **farthest** to the Sun

KEPLER'S

(Law Of Areas)

2

A **line** that connects a planet to the sun sweeps out **equal areas in equal times**

time:		$A \text{ to } B = C \text{ to } D$
area:		$AFB = CFD$
distance:		$AB > CD$
linear speed:		$A \text{ to } B > C \text{ to } D$

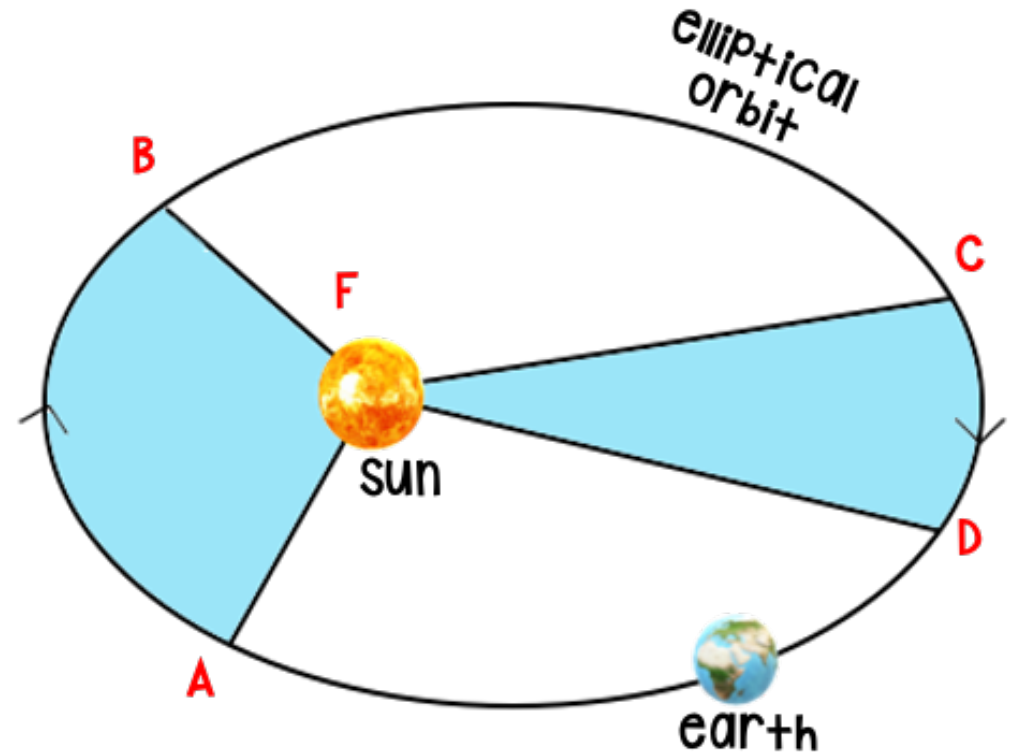

KEPLER'S

(Law Of Period)

3

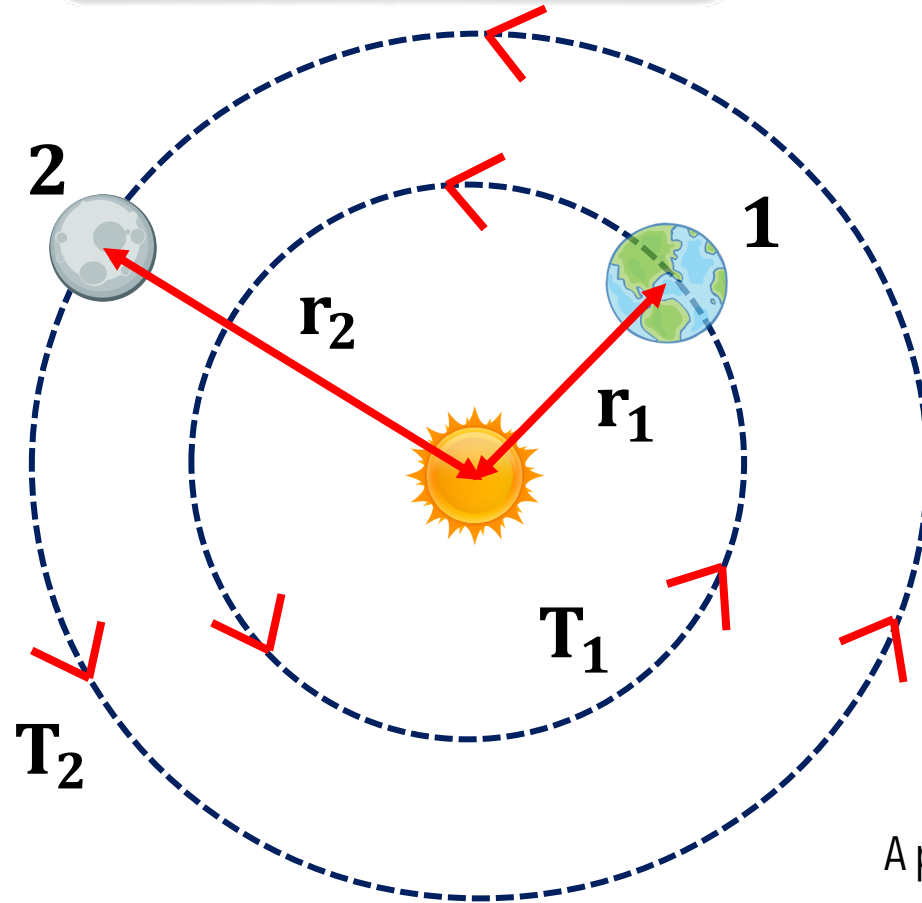

The square of **period** of any planet is **directly proportional to the cube of the radius** of its orbit

$$T^2 \propto r^3$$

$$\frac{T_1^2}{T_2^2} = \frac{r_1^3}{r_2^3}$$

A planet which orbits with a **larger radius** has a **longer orbital period**

LINEAR SPEED

For satellite orbiting Earth

$$v = \sqrt{\frac{GM}{r}}$$

M = Mass of Earth

G = gravitational constant
($6.67 \times 10^{-11} \text{ N m}^2 \text{ kg}^{-2}$)

r = radius of orbit

v = linear speed

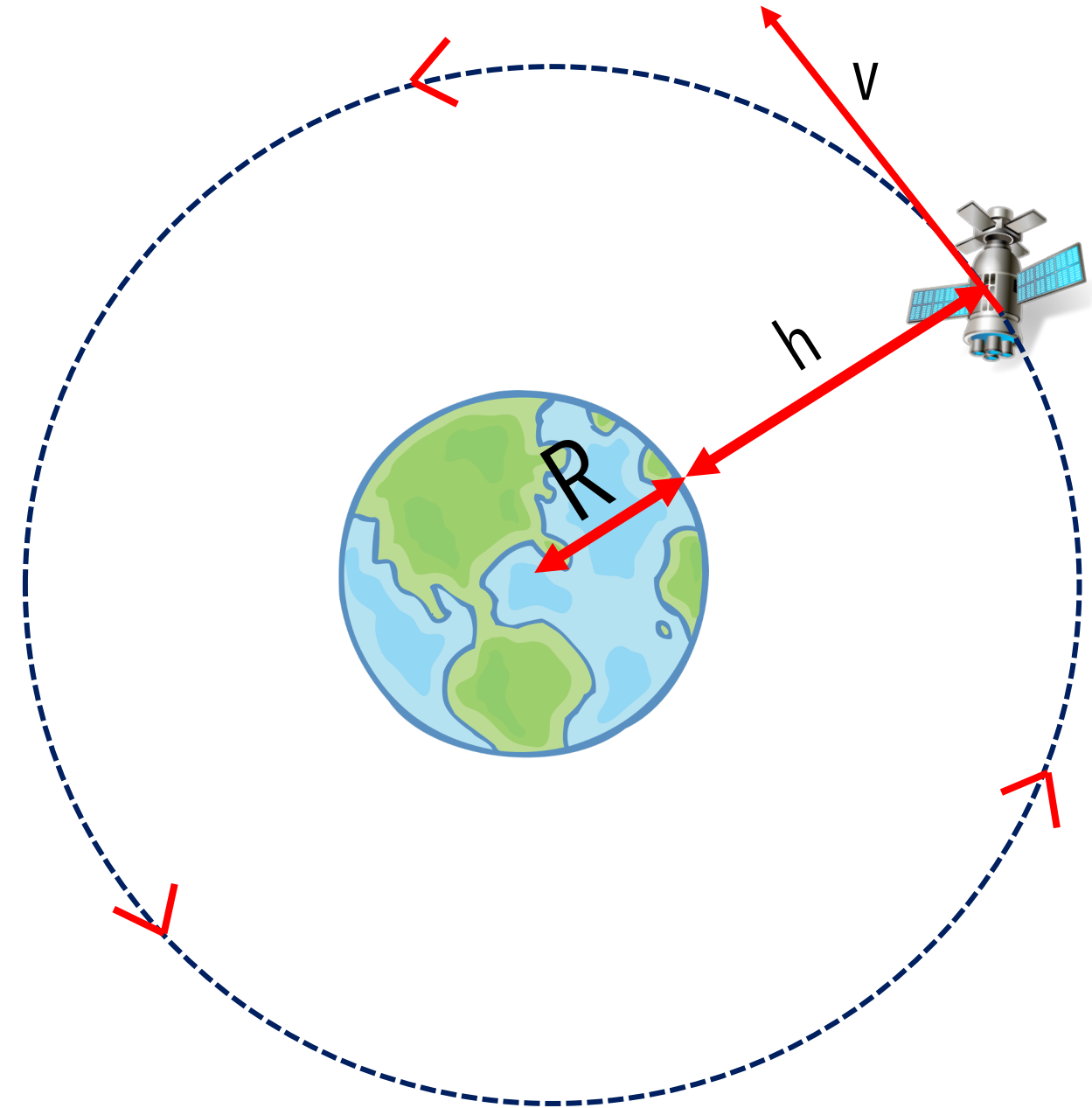

ESCAPE VELOCITY

Minimum velocity needed by an object on the surface of the Earth to overcome gravitational force and escape to outer space

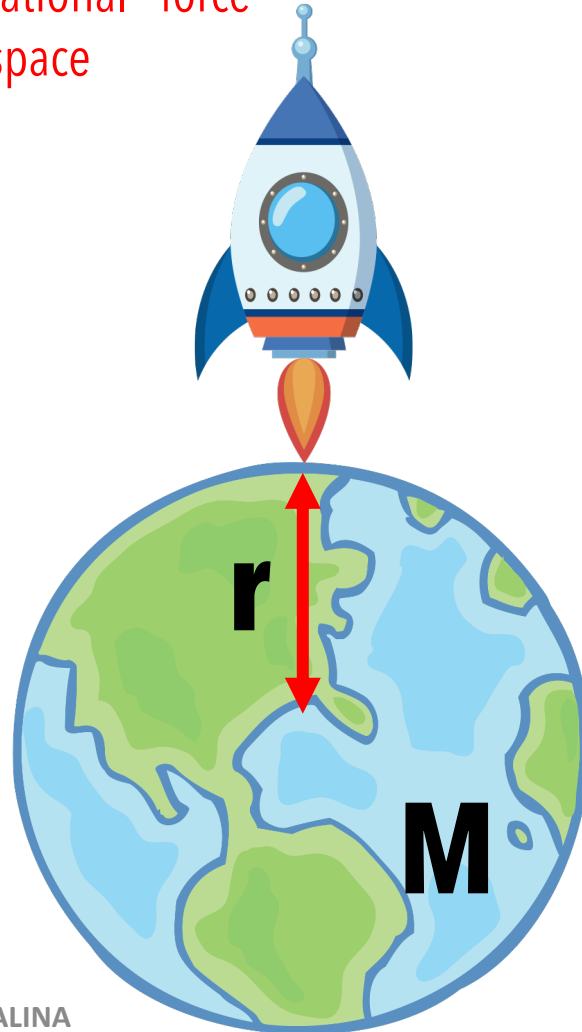

$$v = \sqrt{\frac{2GM}{r}}$$

M = Mass of Earth

G = gravitational constant
($6.67 \times 10^{-11} \text{ N m}^2 \text{ kg}^{-2}$)

r = Distance of object (From the centre of Earth)

v = linear speed

Geostationary satellites

Orbit at: Geostationary Earth Orbit

Direction of rotation: **same** to Earth's rotation

Orbital period: **24 hours**
(period of Earth's rotation)

Specific FUNCTION:
COMMUNICATION satellite

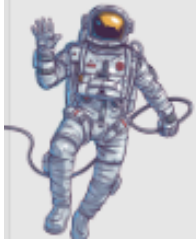

Example: **MEASAT**

versus non-geostationary satellites

FUNCTION:
Orbit the Earth

LINEAR SPEED:

$$v = \sqrt{\frac{GM}{r}}$$

ORBITAL PERIOD:

$$T = \sqrt{\frac{4\pi^3 r^3}{GM}}$$

Orbit at: **LOWER** or **HIGHER**
Geostationary Earth Orbit

Direction of rotation: **same** to Earth's rotation

Orbital period: **<** or **>** than **24 hours**

Specific FUNCTION: **EARTH IMAGING**
GPS &
WEATHER FORECAST

Example: TiungSAT
RazakSAT
Pipit
ISS

